

BOGIE AXLES

 **MADE IN GERMANY**

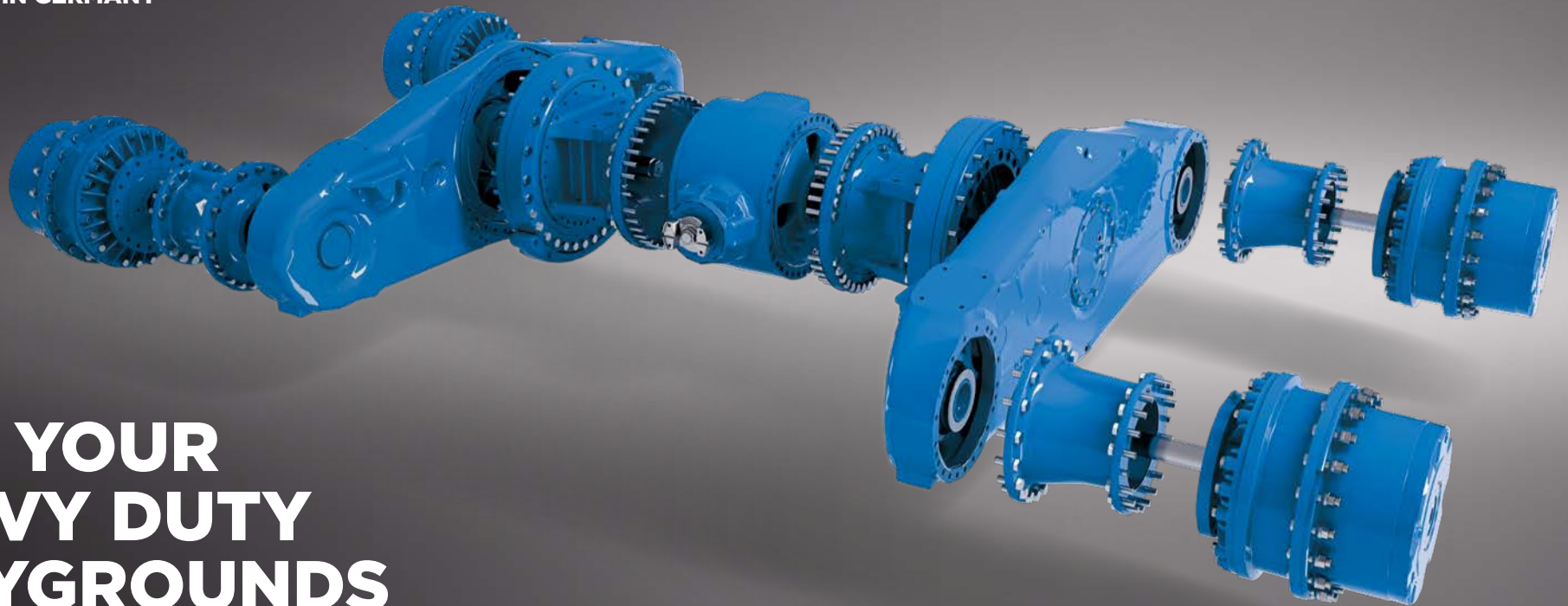

**FOR YOUR
HEAVY DUTY
PLAYGROUNDS**



NAF • MODULAR-MINDED AXLES

NAFAXLES.COM

MODULAR-MINDED AXLES

With modular thinking, modular processes and modular product configurations, we already provide answers today for the functional, economic and logistic challenges of tomorrow.

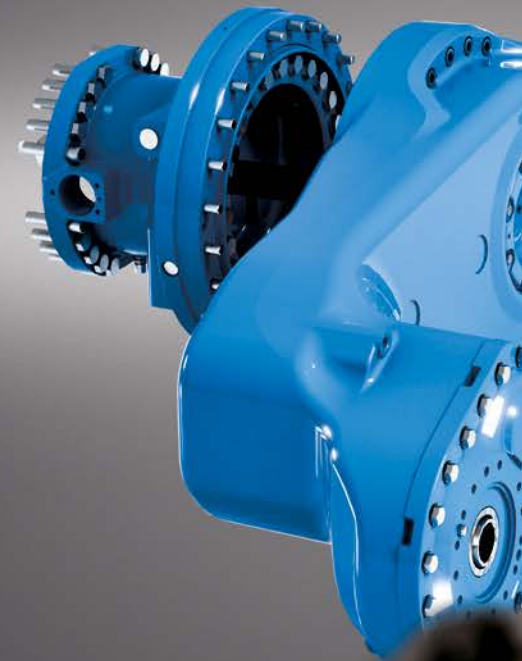

6 SUCCESS FACTORS FOR YOUR AUTOMOTIVE CONCEPT OF THE FUTURE:

- 1 MODULAR AXLE DESIGN**
Proven modular system for complete drive trains – comprising tried-and-tested components.
- 2 MODULAR CUSTOMISATION**
Highly specific, quick and economical customer solutions – with modular development and implementation.
- 3 MODULAR INNOVATION**
All new developments in our customer’s needs is directly integrated into the modular system.
- 4 MODULAR PRODUCTION**
Fluid, customised fabrication based on the modular building block and modular procurement concept.
- 5 MODULAR REPAIR & MAINTENANCE**
Easy repair and spare parts system – by replacing modules, lifetime costs and downtimes are minimised.
- 6 MODULAR SPIRIT**
Corporate culture continually strives to introduce customer-specific competitive advantages.

BOGIE AXLES FAMILY

NAF'S MODULAR BOGIE AXLES COVERING THE WIDEST RANGE IN OFFROAD APPLICATIONS WITH PROVEN RELIABLE DESIGN FOR 40 YEARS.

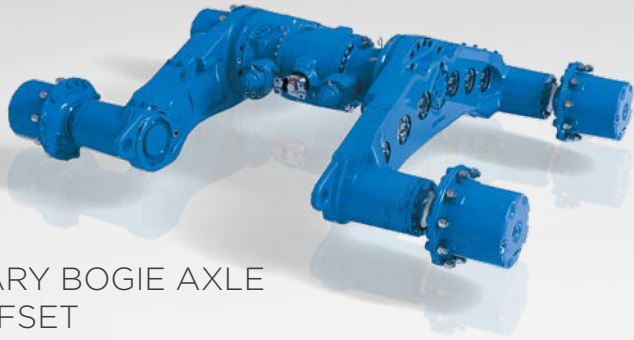

PLANETARY BOGIE AXLE
WITH OFFSET

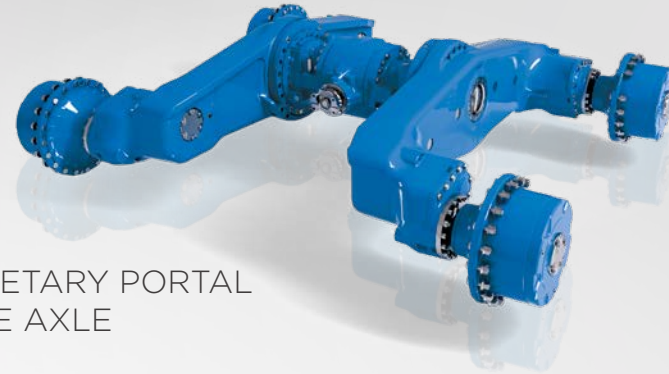

PLANETARY PORTAL
BOGIE AXLE

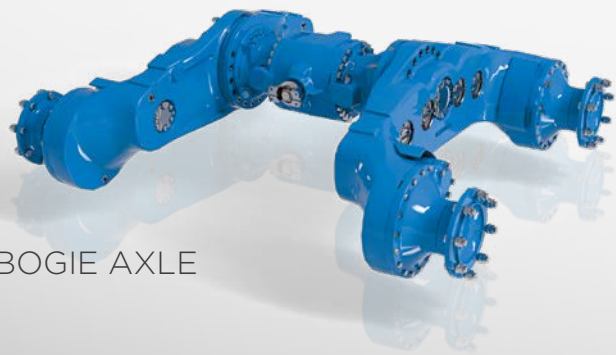

PORTAL BOGIE AXLE



PLANETARY BOGIE AXLE



FOR YOUR HEAVY DUTY PLAYGROUNDS

TECHNICAL HIGHLIGHTS

IMPRESSIVE IN EVERY DETAIL. WE OFFER TECHNICALLY MATURE DRIVE SOLUTIONS FOR ANY FUNCTIONAL REQUIREMENT.

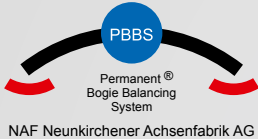
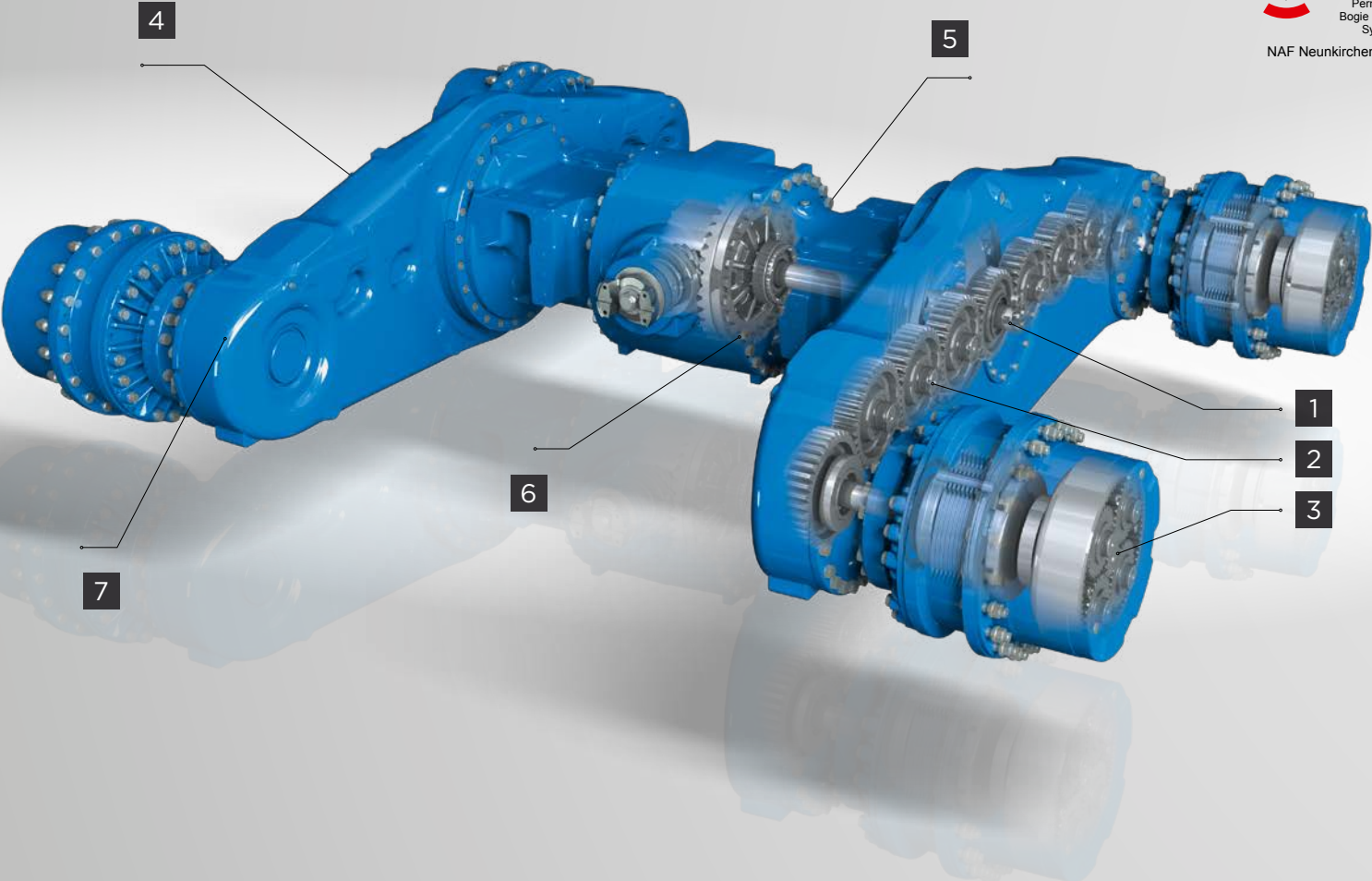

1
PERMANENT BOGIE
BALANCING SYSTEM - PBBS®



2
GEARED BOGIE



3

PATENTED SELF-COOLED
TURBO BRAKE

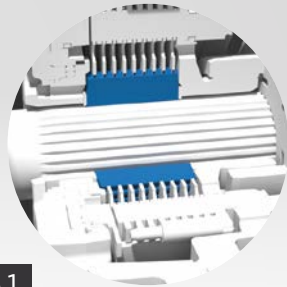

5.1

DIFFERENTIAL LOCKS
MDDL

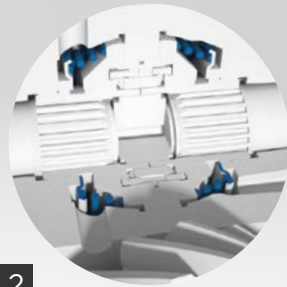

5.2

DIFFERENTIAL LOCKS
NOSPIN®

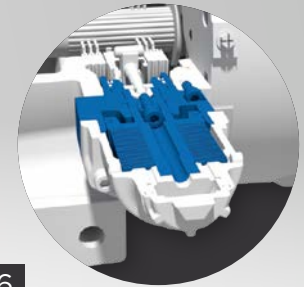

6

ENCAPSULATED BRAKE SYSTEM
BESIDE DIFFERENTIAL

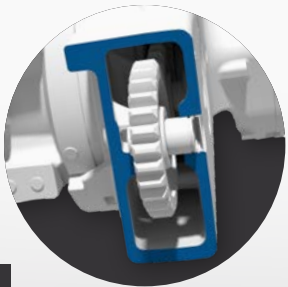

4

CAST DESIGN



5.3

DIFFERENTIAL LOCKS
LIMITED SLIP

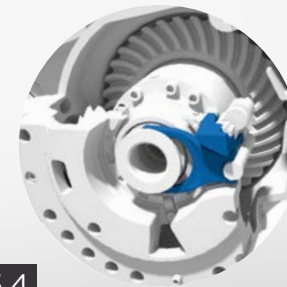

5.4

DIFFERENTIAL LOCKS
DOG CLUTCH



7

PORTAL STAGE FOR MAXIMUM
GROUND CLEARANCE AND FOR
A WIDER RANGE OF RATIOS

PLANETARY BOGIE AXLE WITH OFFSET

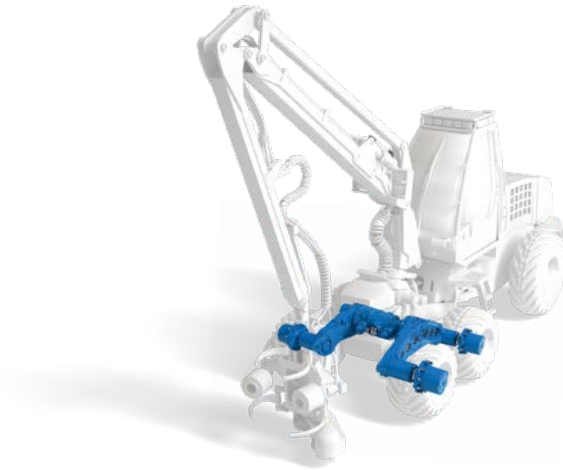

TYPE	TAP 54	TAP 55	TAP 75	TAP 76	TAP 77	TAP 87
Ratio	16.80 - 21.23	15.43 - 22.36	14.75 - 30.35	17.33 - 28.72	17.29 - 27.69	22.24 - 29.08
Static axle load up to [kN]	200	220	290	360	380	380
Dynamic axle load [kN]	100 - 140	150 - 170	160 - 220	255 - 300	255 - 300	300
Max. speed [kph]	40	40	40	40	40	30
Tyre sizes	22.5"	22.5"/24.5"	25"/26.5"	25"/26.5"/28.5"/32"	25"/26.5"/28.5"/32"	28.5"/32"
Parking brake design	Inboard on differential					
Service brake design	Inboard on differential		Inboard on differential / Planetary turbobrake			
Input torque [Nm]	Max. 3500	Max. 4500	Max. 5600	Max. 6000	Max. 7500	Max. 7500
Input RPM	Max. 3400	Max. 3400	Max. 2800	Max. 3000	Max. 3000	Max. 3000
Axle width [mm]	1890 - 2335	2118 - 2378	2081 - 2798	2508 - 2884	2758 - 2862	2922 - 2966
Flange-to-flange [mm]	1450 - 1869	1860 - 2120	1860 - 2372	2130 - 2458	2380 - 2460	2468
Inner width [mm]	600 - 780	690 - 900	920 - 1030	810 - 1050	1030 - 1060	1030 - 1060
Bolt circle [mm]	335	335	425	425	425	500
Wheel base [mm]	1300	1400 - 1500	1500	1690 - 1890	1690 - 1890	1690 - 1890
Bogie offset [mm]	200	150/175	150	200	200	200
Drive flange	DIN/MECHANICS/SPICER in different sizes					
Driven by	Flange/ directly attached gearbox/hydrostatic, hydrodynamic or electric driveline					
Differential locks	MDDL/NoSpin*/dog clutch/limited slip					
Optional	PBBS* for all sizes available					



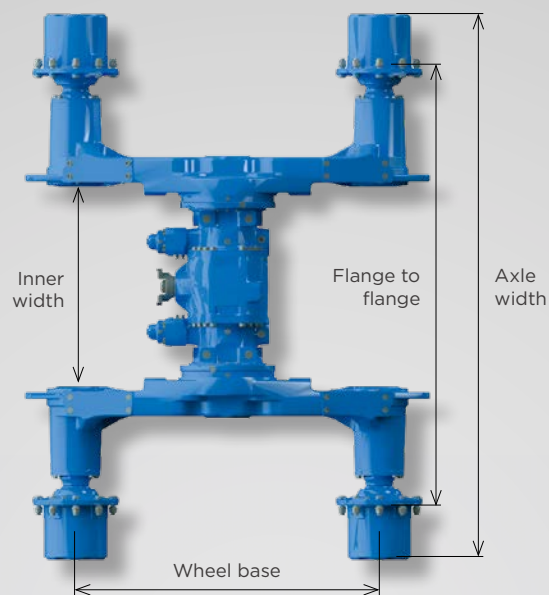
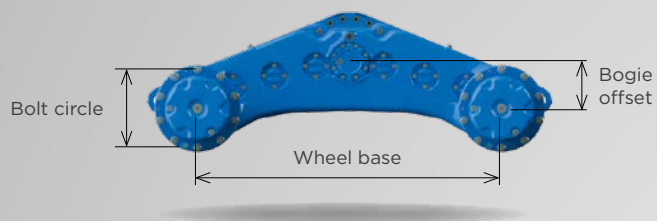

PLANETARY BOGIE AXLE WITH OFFSET

Product features:

- > The TAP axle with offset is especially designed for forestry and offroad applications
- > It can be regarded as our longstanding standard solution which is highly appreciated on the market
- > Despite the elevation it is a compact and lightweight product

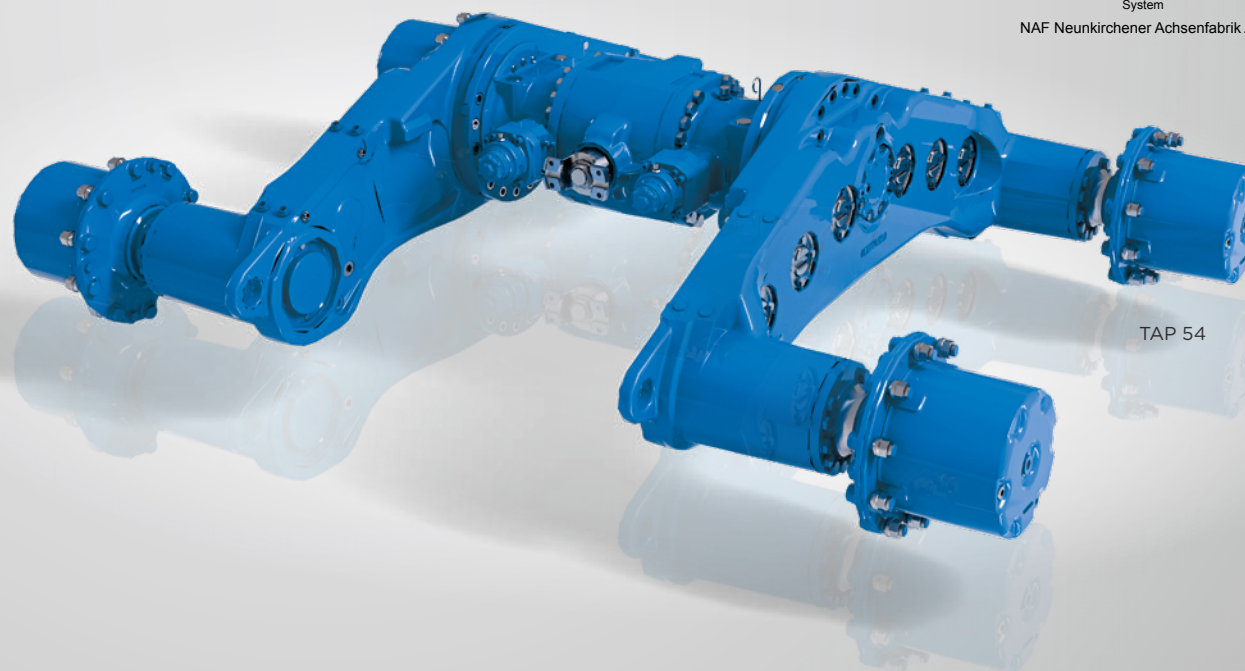
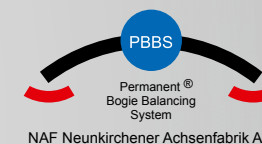

PORTAL BOGIE AXLE

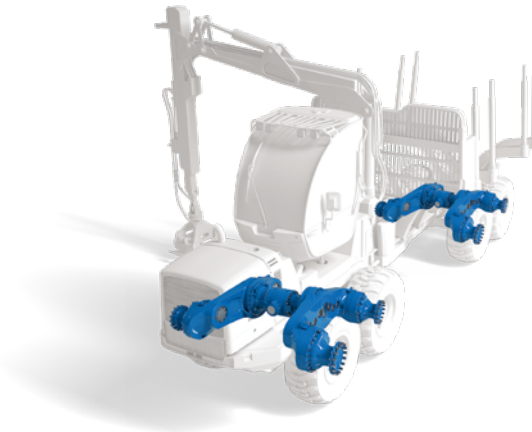

TYPE	PTA 44	PTA 54	PTA 55	PTA 56
Ratio	19.5 - 20.30	19.5 - 20.30	14.59 - 29.38	22.14 - 25.82
Static axle load up to [kN]	180	180	280	360
Dynamic axle load [kN]	120	120	170 - 220	230 - 255
Max. speed [kph]	30	30	30	30
Tyre sizes	22.5"	22.5"	24.5" / 25" / 26.5"	25" / 26.5"
Parking brake design	Inboard on differential			
Service brake design	Inboard on differential			
Input torque [Nm]	Max. 3500	Max. 3500	Max. 5200	Max. 6800
Input RPM	Max. 2800	Max. 2800	Max. 2800	Max. 2800
Axle width [mm]	1873 - 2047	1873 - 2047	2094 - 2500	2480 - 2640
Flange-to-flange [mm]	1779 - 1953	1779 - 1953	2000 - 2406	2390 - 2550
Inner width [mm]	739 - 940	739 - 940	638 - 952	960 - 1070
Bolt circle [mm]	275	335	335	335
Wheel base [mm]	1300	1300	1400 - 1520	1500 - 1640
Bogie offset [mm]	200	200	150/175/200	200
Drive flange	DIN/MECHANICS/SPICER in different sizes			
Driven by	Flange/directly attached gearbox/hydrostatic, hydrodynamic or electric driveline			
Differential locks	MDDL/NoSpin*/dog clutch/limited slip			
Optional	PBBS* for all sizes available			



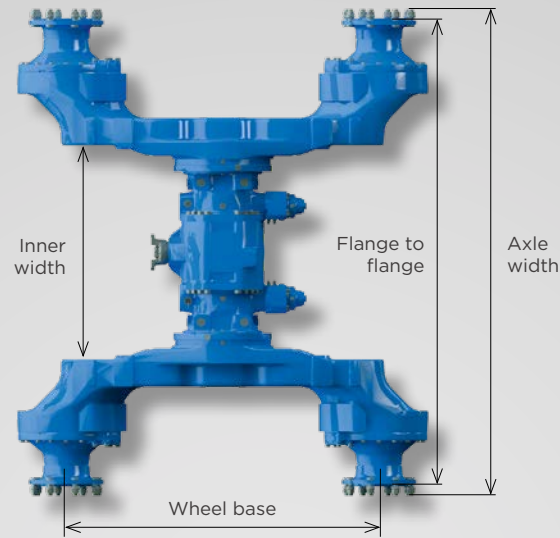

PORTAL BOGIE AXLE

Product features:

- > The PTA axle product range was especially designed for forestry and offroad applications which require a very high spread of ratio possibilities
- > The axles are designed with a portal housing for optimised ground clearance
- > Moreover, all PTA models can be equipped with the patented "Permanent Bogie Balancing System" (PBBS®)
- > PBBS® increases the tractive effort by counteracting the bogie lifting effect

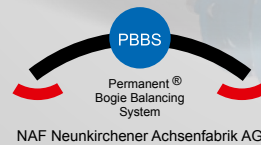

PLANETARY PORTAL BOGIE AXLE

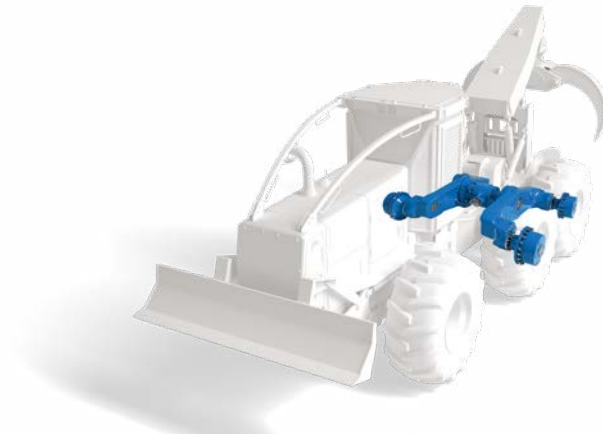

TYPE	PTA 75	PTA 76	PTA 77	PTA 87
Ratio	17.17 - 32.53	22.21 - 36.70	21.24 - 35.87	27.44 - 35.68
Static axle load up to [kN]	290	360	360	360
Dynamic axle load [kN]	220 - 240	200 - 290	300	280 - 300
Max. speed [kph]	30	25	27	25
Tyre sizes	26.5"	26,5"/28.5"/30.5"	26,5"/28.5"/30.5"	28,5"/30,5"/32"
Parking brake design	Inboard on differential			
Service brake design	Inboard on differential			
Input torque [Nm]	Max. 5200	Max. 6000	Max. 7000	Max. 7000
Input RPM	Max. 2800	Max. 2800	Max. 2600	Max. 2700
Axle width [mm]	2900 - 3160	2560 - 2896	2852	2964 - 3016
Flange-to-flange [mm]	2266 - 2300	2304 - 2450	2450	2510 - 2518
Inner width [mm]	958 - 1032	1022 - 1070	1070	1070 - 1082
Bolt circle [mm]	425	425	425	500
Wheel base [mm]	1500 - 1520	1520 - 1640	1640 - 1720	1640 - 1980
Bogie offset [mm]	150/200	200	200/230	200
Drive flange	DIN/MECHANICS/SPICER in different sizes			
Driven by	Flange/ directly attached gearbox/hydrostatic, hydrodynamic or electric driveline			
Differential locks	MDDL/NoSpin*/dog clutch/limited slip			
Optional	PBBS® for all sizes available			



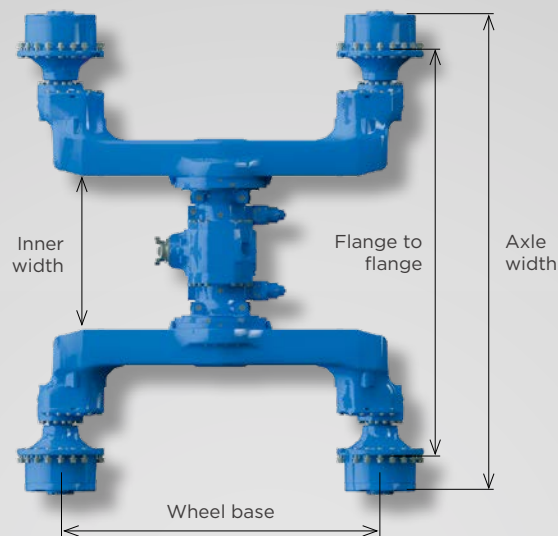

PLANETARY PORTAL BOGIE AXLE

Product features:

- > The PTA axle product range was especially designed for forestry and offroad applications which require a very high spread of ratio possibilities
- > The axles are designed with a portal housing for optimised ground clearance
- > Additionally equipped with a planetary drive on the wheel ends, these axles provide deeper ratio and higher torque than standard bogie axles
- > Moreover, all PTA models can be equipped with the patented "Permanent Bogie Balancing System" (PBBS®)
- > PBBS® increases the tractive effort by counteracting the bogie lifting effect

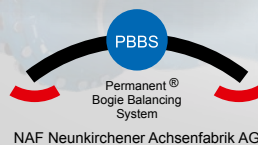
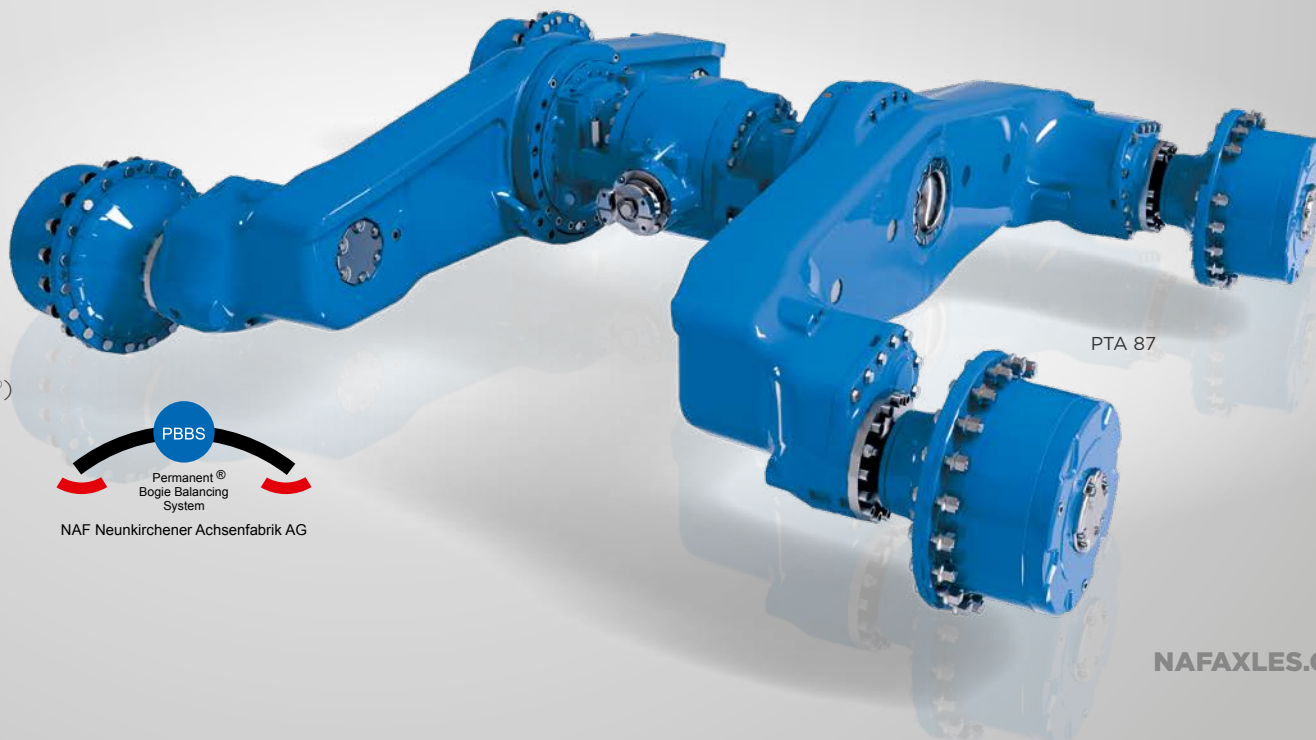

PLANETARY BOGIE AXLE

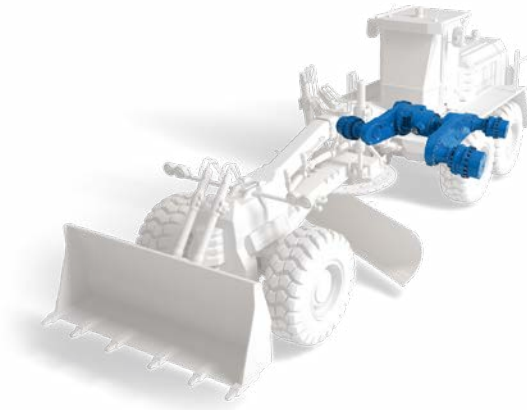

TYPE	TAP 54	TAP 55	TAP 75	TAP 76	TAP 77	TAP 78	TAP 87	TAP 89
Ratio	16,8 - 21,2	16.73 - 21.07	18.53 - 24.1	17.48- 23.01	19.623 - 20.1	19.74	21.8	19.38 - 21.8
Static axle load up to [kN]	200	220	260	360	420	420	460	510
Dynamic axle load [kN]	140	110	130	255	345	345	464	484
Max. speed [kph]	40	45	45	50	55	55	60	58
Tyre sizes	400/70-20 up to 800 x 22,5	24" / 25"	24" / 25"	24" / 25" / 30.5"	25" / 30"	25" / 30"	25" / 30"	25" / 29"
Parking brake design	Inboard on differential				Available on request			
Service brake design	Inboard on differential / Planetary brake							
Input torque [Nm]	2.600 - 3.000	Max. 3900	Max. 4500	Max. 5300	Max. 5700	Max. 7500	Max. 9000	Max. 12200
Input RPM	3.800 - 3.500	Max. 3500	Max. 3500	Max. 3900	Max. 3900	Max. 3900	Max. 3500	Max. 3300
Axle width [mm]	2085 - 2335	2342 - 2420	2402	2420 - 2756	2668 - 2908	2892	3132	3176 - 3368
Flange-to-flange [mm]	1619 - 1869	1920 - 1980	2024	2042 - 2330	2250 - 2490	2490	2678	2678 - 2870
Inner width [mm]	740 - 900	1180	1180	1056 - 1198	860	1340	1416	1136 - 1406
Bolt circle [mm]	335	335	425	425	425	425	500	500
Wheel base [mm]	1300 (with bogie offset of 200 mm for optimised ground clearance)	1540	1540	1540 - 1632	1771	1771	1960	1960
Drive flange	DIN/MECHANICS/SPICER in different sizes							
Driven by	Flange/directly attached gearbox/hydrostatic, hydrodynamic or electric driveline							
Differential locks	MDDL/NoSpin®/dog clutch/limited slip							
Optional	PBBS® for all sizes available							



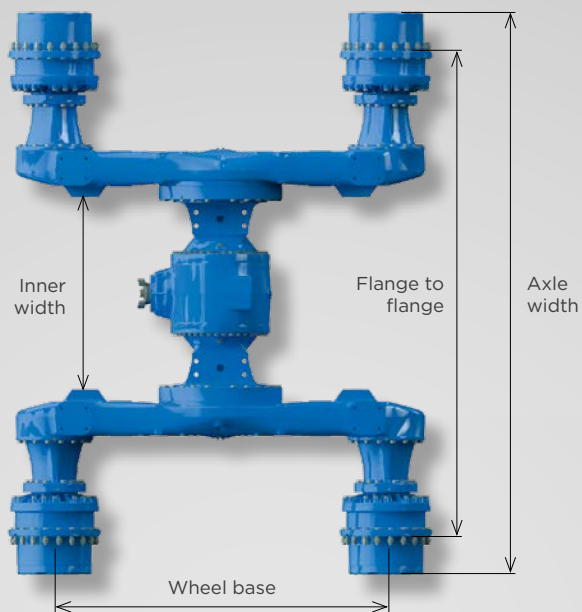
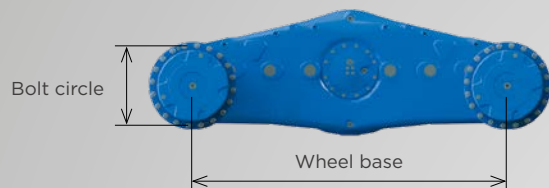

PLANETARY BOGIE AXLES

Product features:

- > The TAP axles without bogie offset is especially designed for the use in construction machinery
- > It can be regarded as our longstanding standard solution which is highly appreciated on the market

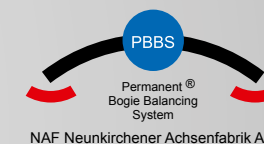

NAF Neunkirchener Achsenfabrik AG

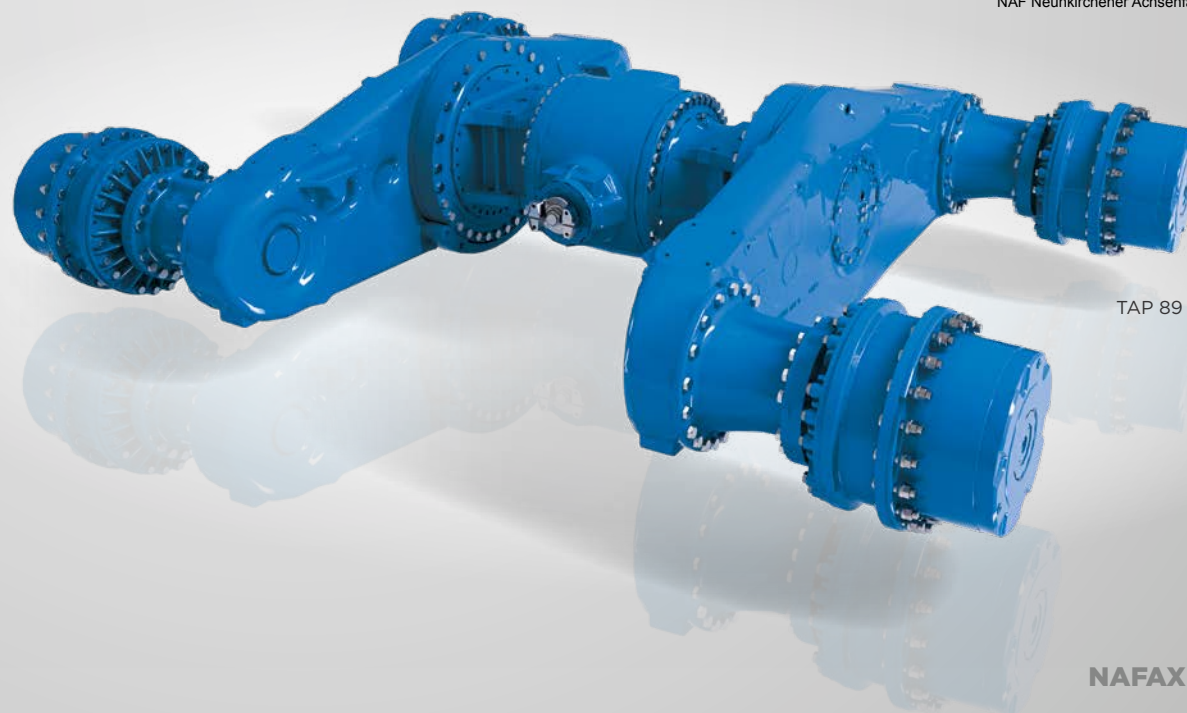

TAP 89



FOR YOUR HEAVY DUTY PLAYGROUNDS

As the leading market manufacturer of drive trains for self-propelled forestry machines, NAF has been tackling a wide variety of the most extreme deployment conditions for many decades. The modular system, which has evolved from this set of requirements, covers the individual assignments that need to be met by heavy-duty vehicle manufacturers across many different sectors. With this passion, which made us the market leader for drives in forestry machines, we create your individual drive solutions.

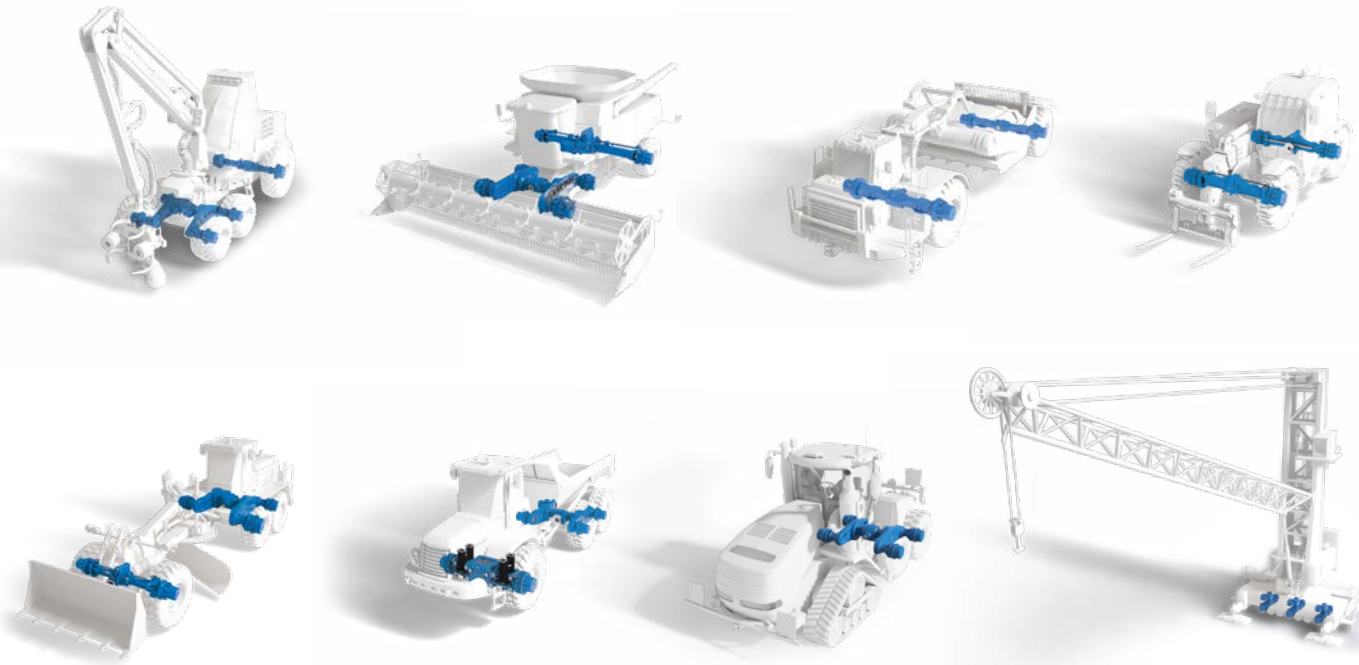
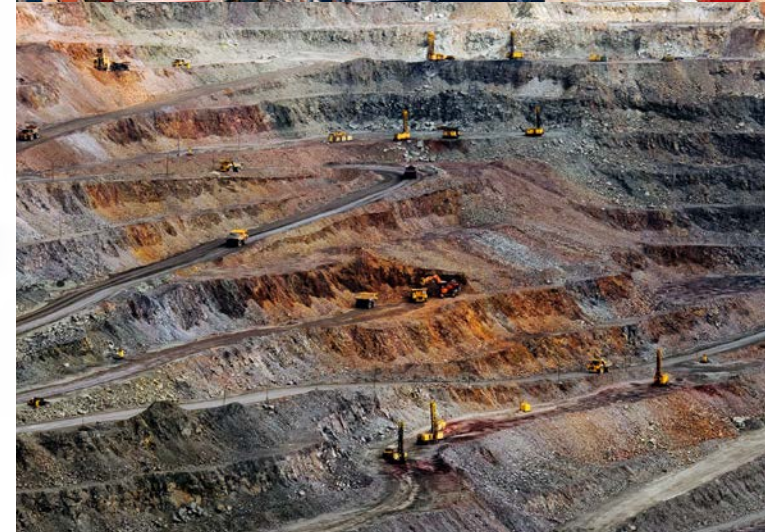

NAF • MODULAR-MINDED AXLES



FOR YOUR HEAVY DUTY PLAYGROUNDS

NAF's drive solutions are modelled for their special use and application. Our modular designs and the experience from more than 621 projects are the basis to satisfy your requirements in the most efficient way. We are pleased to present our comprehensive product portfolio!



RIGID AXLES

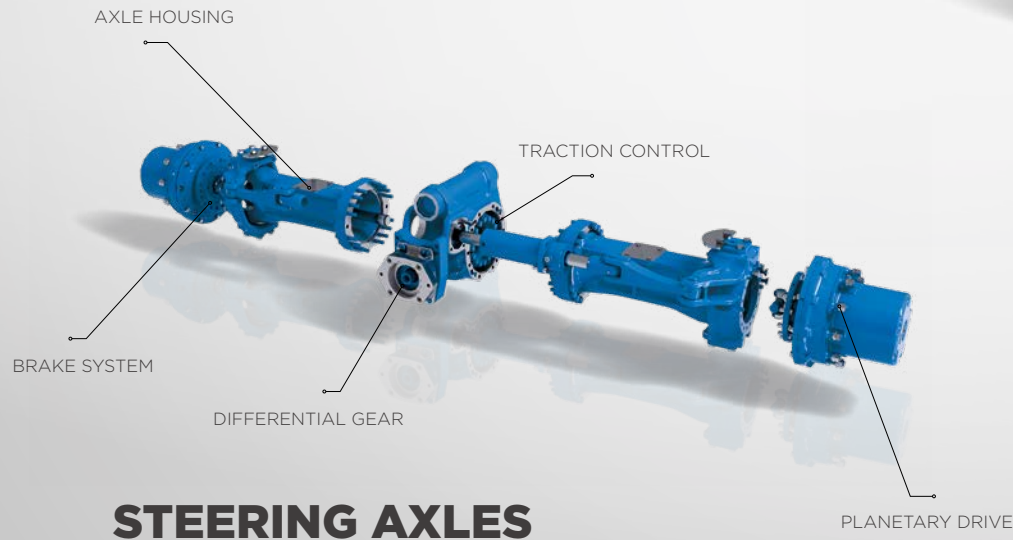

STEERING AXLES

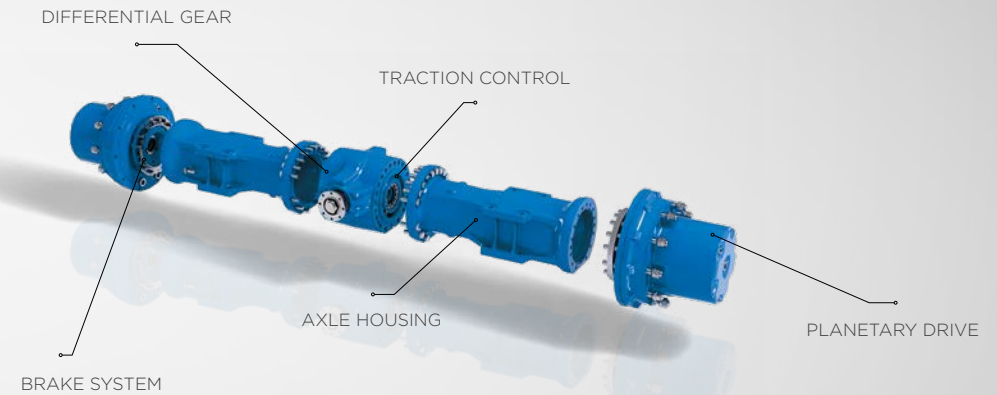

GEARBOXES

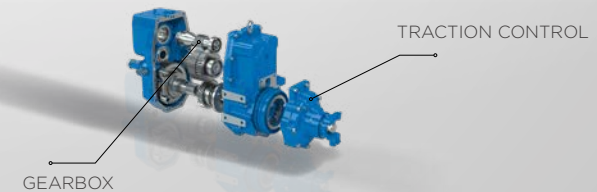

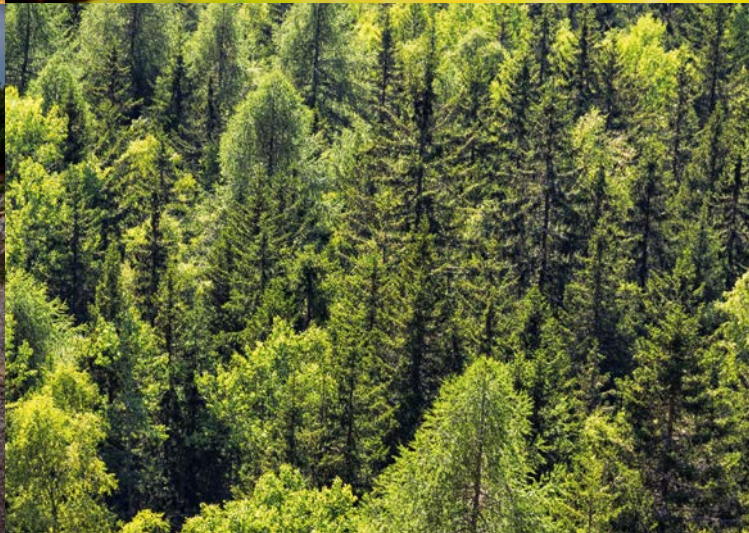

NAF AG is particularly proud of the awards given to us by our customers that honour our outstanding achievements and cooperative partnerships on all levels. This is our benchmark for all customer relations.

NAF is the expert for power transmission, traction and load capacity on mobile working machines. Our gears and axles create a substantial competitive advantage in the heavy-duty off-highway industry. As a system partner we have been mastering the tasks of our market-leading customers since 1960 and invest 5% of our annual turnover into research and development.

As our customer you benefit directly from our passion for innovation that guarantees your success.



AT HOME ON **3** CONTINENTS



48

Supplied countries worldwide

More than 650

Employees in total

28.000 m²

of production area

40.000

Components sold each year

18

Patents and
protected innovations

20

Employees working in
R&D/PDP

Headquarters and production

NAF Neunkirchener Achsenfabrik AG
Weyhausenstrasse 2
91077 Neunkirchen am Brand
Germany
T: +49 9134 702-0
F: +49 9134 702-653
info@nafaxles.com

For more information about our
branches in North America, France,
Germany (HQ), Russia & China visit:



NAF • MODULAR-MINDED AXLES

NAFAXLES.COM